

800mA Ultra-Low Vin Low Dropout Voltage Linear Regulator

GENERAL DESCRIPTION

BL8074 series are a group of positive voltage output, high precise, and low power consumption voltage regulator. Voltages are selectable in 100mV steps within a range of 1.2V to 5.0V. It also can be customized on command.

BL8074 series have excellent load and line transient response and good temperature characteristics, which can assure the stability of chip and power system. And it uses trimming technique to guarantee output voltage accuracy within $\pm 2\%$.

BL8074 series are available in SOT-89-3 package, which is lead (Pb)- free.

FEATURES

- Low Quiescent Current: 100uA at 5V
- High PSRR: 65dB range to 1KHz
- Low Output Noise: 44uVRMS
- Low Dropout: 200mV@Iout=0.8A, Vout=3.3V
- Maximum output current: 800mA
- Highly Accurate: $\pm 2\%$
- Low ESR Ceramic Capacitor Compatible

APPLICATIONS

- Reference Voltage Source
- Battery Powered Equipment
- PC Peripherals
- Wireless Devices
- Instrumentation

TYPICAL APPLICATION

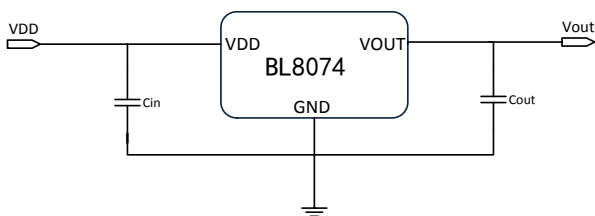

BLOCK DIAGRAM

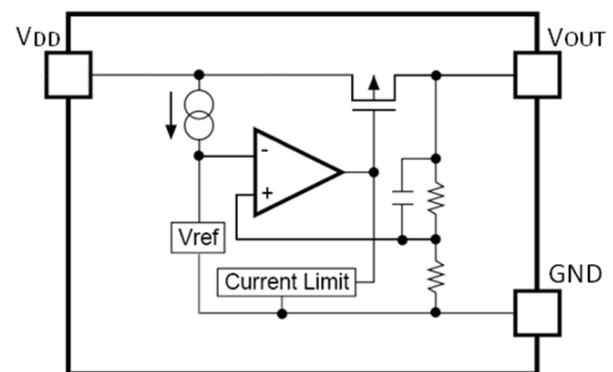

ORDERING INFORMATION

BL8074 ①②③④⑤

Code	Description
①	Temperature&Rohs: C:-40~85°C ,Pb Free Rohs Std.
②	Package type: C3:SOT-89-3
③	Packing type: TR:Tape&Reel (Standard)
④	Output voltage: e.g. 12=1.2V 18=1.8V 25=2.5V 33=3.3V 50=5.0V
⑤	Voltage accuracy: 1=±1%(Customized) Blank(default)=±2%

MARKING DESCRIPTON

Output Voltage Code X

VOUT	Code	VOUT	Code	VOUT	Code
1.2V	2	2.9V	9	4.3V	3
1.3V	3	3.0V	0	4.4V	4
1.4V	4	3.1V	1	4.5V	5
1.5V	5	3.2V	2	4.6V	6
1.8V	8	3.3V	3	4.7V	7
2.0V	0	3.4V	4	4.8V	8
2.1V	1	3.5V	5	4.9V	9
2.2V	2	3.6V	6	5.0V	0
2.3V	3	3.7V	7	5.1V	1
2.4V	4	3.8V	8	5.2V	2
2.5V	5	3.9V	9	5.3V	3
2.6V	6	4.0V	0	5.4V	4
2.7V	7	4.1V	1	5.5V	5
2.8V	8	4.2V	2		

XX: Output Voltage, e.g. 18=1.8V 33=3.3V

Y: The Year of manufacturing, "1" stands for year 2011, "2" stands for year 2012, and "8" stands for year 2018.

W: The week of manufacturing. "A" stands for week 1, "Z" stands for week 26, "A" stands for week 27, "Z" stands for week 52.

PIN CONFIGURATION

Product Classification		BL8074CC3TR□□
JBXX LLBYW	JB:Product Code	<p>SOT-89-3 1 GND 2 VDD 3 VOUT</p>
	XX:Output Voltage	
	LL:LOT NO.	
	B:FAB Code	
	YW:Date Code	
VDD	Supply Voltage Input	
GND	Ground Pin	
VOUT	Output Voltage	

ABSOLUTE MAXIMUM RATING

Parameter	Value
Max Input Voltage	8V
Max Operating Junction Temperature (T _J)	145°C
Ambient Temperature (T _A)	-40°C~85°C
Power Dissipation	SOT-89-3 500mW
Storage Temperature (T _S)	-40°C~150°C
Lead Temperature & Time	260°C, 10 Sec

RECOMMENDED WORK CONDITIONS

Parameter	Value
Input Voltage Range	Max. 6V
Ambient Temperature	-40°C~85°C
Operating Junction Temperature (T _J)	125°C

ELECTRICAL CHARACTERISTICS

Test Conditions: $C_{IN}=4.7\mu F, C_{OUT}=4.7\mu F, T_A=25^\circ C$, unless otherwise specified.

Symbol	Parameter	Conditions	Min	Typ	Max	Units
V_{DD}	Input Voltage		1.5*		6	V
V_{OUT}	Output Voltage	$V_{OUT}>1.5$	$V_{DD}=\text{Set } V_{OUT}+1V$	V_{OUT}	$V_{OUT} \times 1.02$	V
		$V_{OUT} \leq 1.5$	$1mA \leq I_{OUT} \leq 10mA$		$V_{OUT} - 0.03$	
$I_{OUT} \text{ (Max.)}^{**}$	Maximum Output Current	$V_{DD}-V_{OUT}=1V$	0.8			A
V_{DROP}	Dropout Voltage	$V_{OUT}=3.3V, I_{OUT}=1A$		300	500	mV
$\frac{\Delta V_{out}}{\Delta V_{in} \cdot V_{out}}$	Line Regulation	$I_{OUT}=10mA, 4V \leq V_{DD} \leq 6V$		0.05	0.2	%/V
ΔV_{out}	Load Regulation	$V_{DD}=\text{Set } V_{OUT}+1V$ $1mA \leq I_{OUT} \leq 2.5A$		30	60	mV
I_s	Supply Current	$V_{DD}=\text{Set } V_{OUT}+1V, V_{OUT}$ Floating		100	150	μA
$\frac{\Delta V_{out}}{\Delta T \cdot V_{out}}$	Output Voltage Temperature Coefficient	$I_{OUT}=10mA$		± 100		ppm/ $^\circ C$
PSRR	Ripple Rejection	$f=100Hz, \text{Ripple}=0.5Vp-p,$ $V_{DD}=\text{Set } V_{OUT}+1V$		65		dB
en	Output Noise	$BW=10Hz \sim 100KHz$		44		μV_{rms}

Note: * $I_{out}=350mA @ V_{in}=1.5V, V_{out}=1.2V$

**The maximum power rating of each package is a constant, so along with the change of I_{LOAD} , the $V_{DD}-V_{OUT}$ should be controlled to a certain range to ensure the normal operation.

TYPICAL PERFORMANCE CHARACTERISTICS

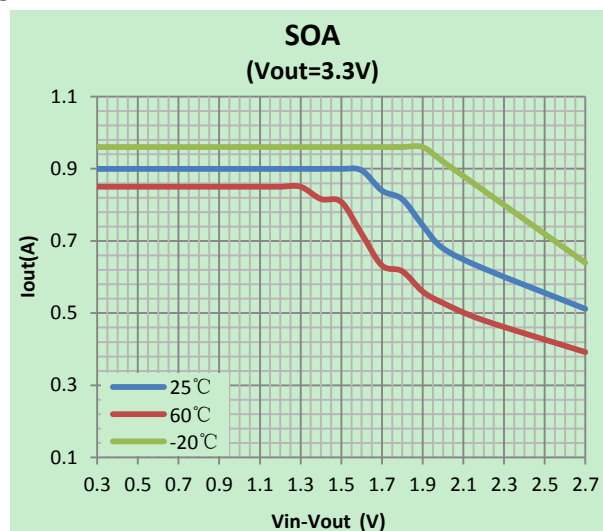
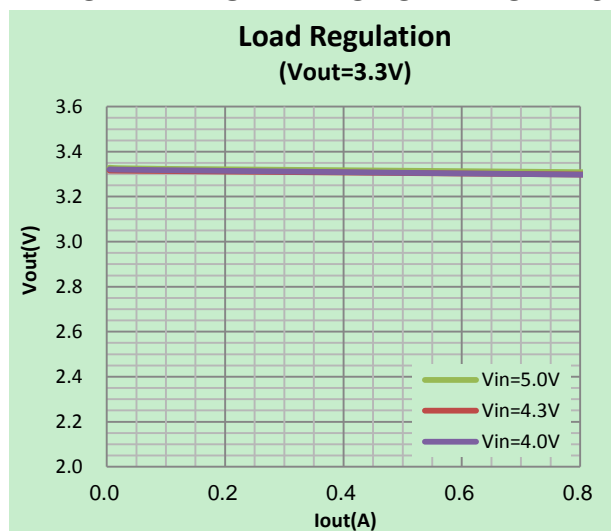

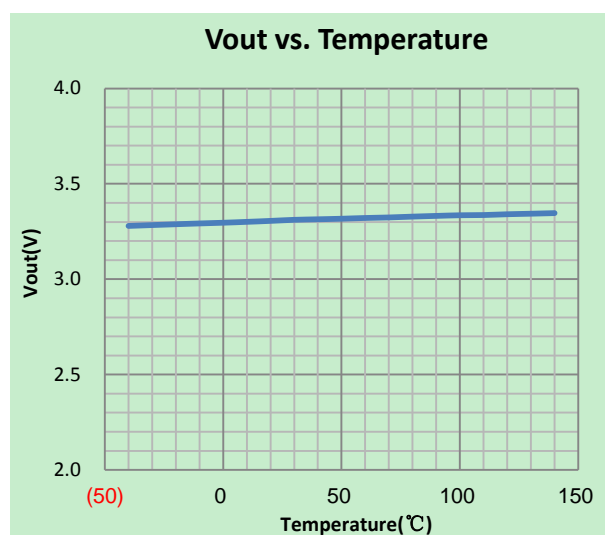
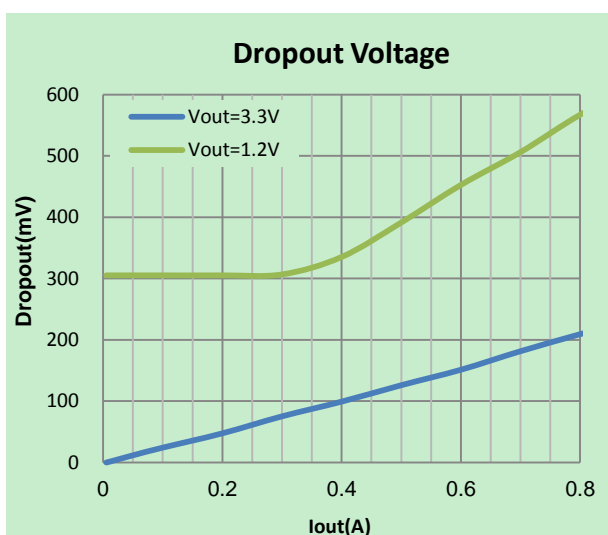
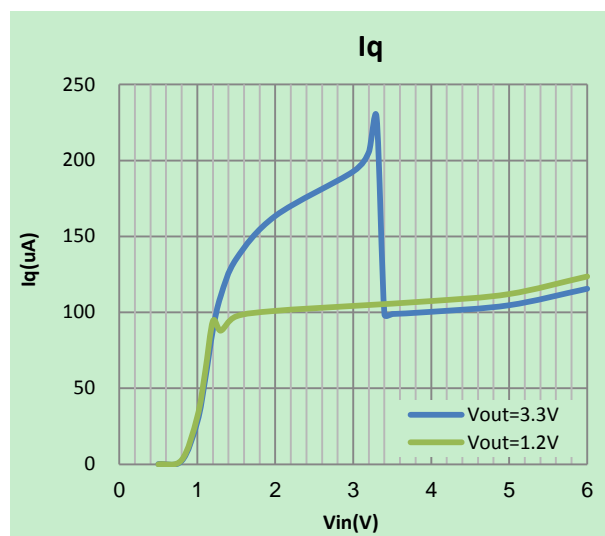
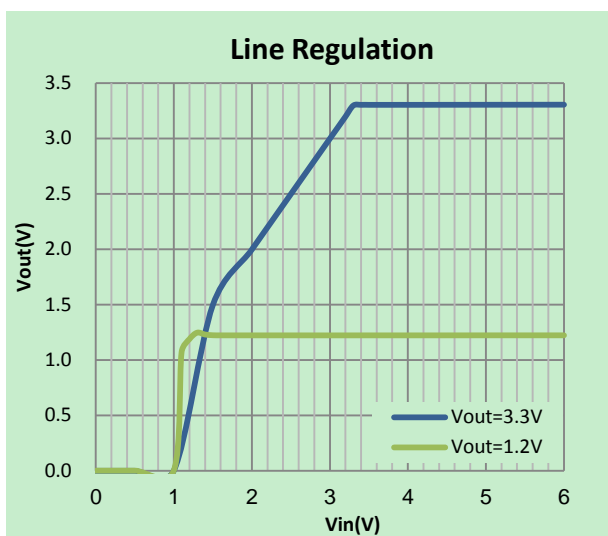

Load Transient Response (Vin=5V, Vout=3.3V)
Cin=1uF, Cout=1uF, Iout=1mA-100mA

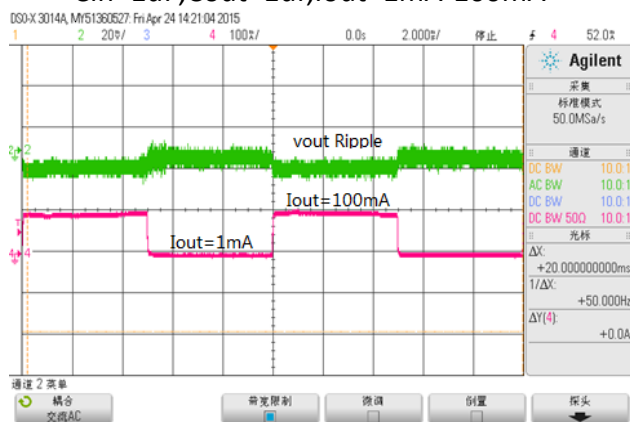

Line Transient Response (Vin=5V, Vout=3.3V)
Cin=1uF, Cout=1uF, Iout=10mA, Vin=4.3V-5.3V

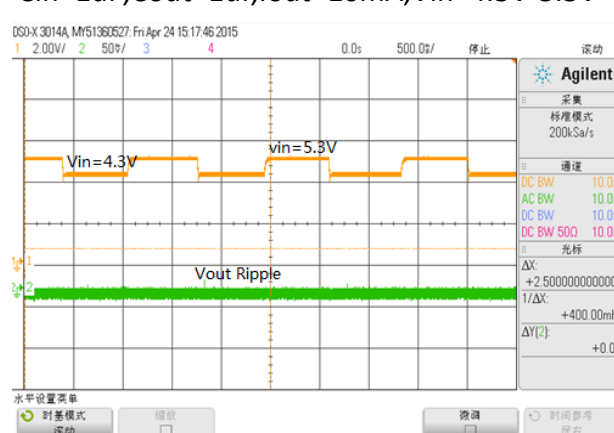

PACKAGE LINE

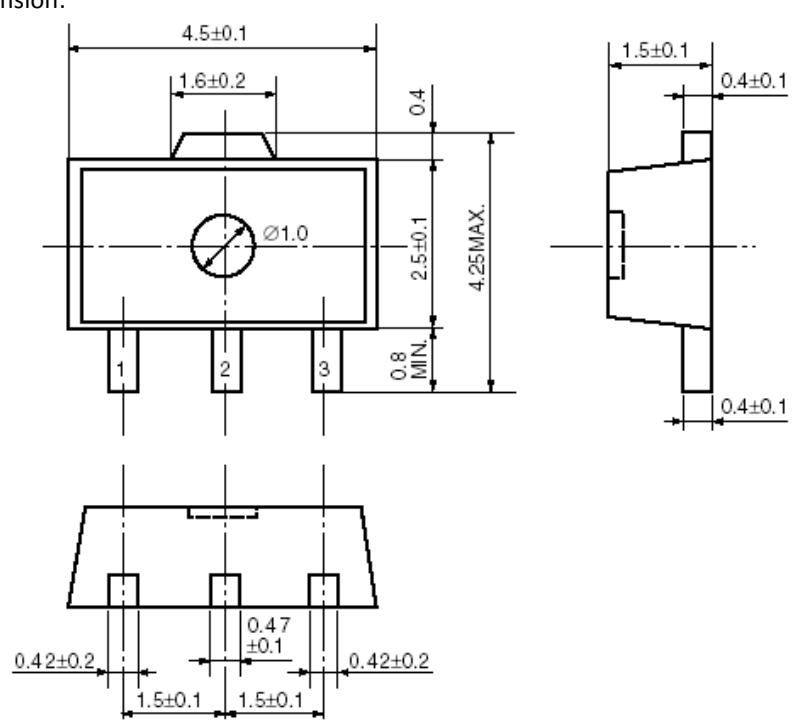
Package	SOT-89-3	Devices per reel	1000Pcs	Unit	mm
Package Dimension:  <p> The technical drawing illustrates the SOT-89-3 package in three views: <ul style="list-style-type: none"> Top View: Shows a rectangular body with a width of 4.5 ± 0.1 mm and a length of 2.5 ± 0.1 mm. A central circular feature has a diameter of $\varnothing 1.0$ mm. Three leads are located at the bottom, with a minimum height of 0.8 mm. A top feature has a width of 1.6 ± 0.2 mm and a height of 0.4 mm. The maximum height of the package is 4.25 mm. Side View: Shows the profile of the package with a top width of 1.5 ± 0.1 mm and a bottom width of 0.4 ± 0.1 mm. Bottom View: Shows the lead layout with a central spacing of 0.47 ± 0.1 mm between leads. The distance from the center to each lead is 1.5 ± 0.1 mm. The distance from the package edge to the center of the lead array is 0.42 ± 0.2 mm. </p>					